

DESIGN AND PRODUCTION OF LEAD RUBBER BEARINGS FOR EARTHQUAKE ABSORBERS

by Henni -

Submission date: 19-Feb-2024 09:45AM (UTC+0700)

Submission ID: 2298244528

File name: 1gwk2023-26-37.pdf (1.17M)

Word count: 7539

Character count: 39116

RESEARCH ARTICLE

DESIGN AND PRODUCTION OF LEAD RUBBER BEARINGS FOR EARTHQUAKE ABSORBERS

Gambiro^{a*}, Hari Nugraha Nurjaman^a, Dwi Dinariana^b, Martinus Nifotuhu Fau^d, Suwito^e, Prijasambada^f, Henni^e, Siti Sujatini^f^aIAPPI, Ikatan Ahli ³⁶cetak Dan Prategang Indonesia.^bCivil Engineering, University of Persada Indonesia Y.A.I, Indonesia;^cCivil Engineering, Podomoro Un ¹⁹rsity, Indonesia;^dCivil Engineering, University of Persada Indonesia Y.A.I, Indonesia;^eIndustrial Engineering, University of Persada Indonesia Y.A.I, Indonesia;^fArchitectural Engineering, University of Persada Indonesia Y.A.I, Indonesia;^{*}Corresponding Author Email: gambiro_s@yahoo.com, hari_nurjaman@yahoo.com, dwi5inariana@yahoo.com, martinusnfau@gmail.com, irsuwito@gmail.com, prijasambada@yahoo.com, henn1_bm@yahoo.com, siti_sujatini1@yahoo.com

This is an open access journal distributed under the Creative Commons Attribution License CC BY 4.0, which permits unrestricted use, distribution, and reproduction in any medium, provided the original work is properly cited

ARTICLE DETAILS

Article History:

Received 23 February 2023
Revised 15 March 2023
Accepted 28 April 2023
Available Online 01 May 2023

ABSTRACT

43

Lead Rubber Bearing (LRB) is a passive type of base isolation that can be used as a damper for earthquake vibrations on bridges and buildings. The components that make up the LRB are several layers of rubber laminated to steel plates to increase vertical rigidity. LRB is also reinforced with lead cores to dissipate earthquake energy that enters the bridge structure or buildings. This paper will explain the design and production of LRB and test the results of the analysis. In this design, the properties of the materials used in the LRB are explained, the function of each material, the relationship between the design and the need to absorb earthquake loads on bridge structures or buildings. It also explains the determination of elastomeric thickness and number of layers, size of insulator, elastomer thickness and number of layers, number of rubber layers, total height, vertical and horizontal stability checks. The production method is very important to get a quality LRB product. Production starts from material selection, vulcanization process and quality control. The research was carried out successfully by studying the literature and technical analysis by carrying out several simulations with various dimensions to get better performance. Several developments were made to get better LRB performance. The damping of structures without base isolation is generally +/- 5%. For the need for good performance against earthquake loads, the attenuation can be increased to 20–30%. This is very useful for reducing earthquake loads, when a decrease in building acceleration cannot be obtained in tall buildings with base isolation. Likewise with the dimensions of the lead core. This research is still limited to theoretical analysis and prototyping, because no experiments have been carried out in the laboratory or applied to a construction project

KEYWORDS

Lead rubber bearing; lead core; damping ratio; vulcanization; reduce acceleration

1. INTRODUCTION

The conventional structure for multi-storey buildings consists of a lower structure (fo ⁴⁰ation) and a superstructure. These two parts are connected by a fixed base. This means that the movement of the upper structure will be influenced and follow the movement of the lower structure which vibrations arise due to the movement of the ground. To prevent the vibrations from propagating, the lower and upper structures are isolated from ground motions due to earthquake loads. E ³⁴ insulation is one of the protection systems against earthquake loads. The term isolation refers to the reduced interaction between the structure and the soil. Tempora ³⁸ called "Basic Isolation", because the isolation system is located un ²r the structure. Base isolation is a passive control system (requires no external force or energy to activate). The base isolators used in this system reduce the effects of earthquakes by separating bui ²ng components from direct contact with the ground. This system is very effective for seismic protection of new frame buildings and for seismic reinforcement of existing ones. Lead Rubber Bearing (LRB) is a passive

type of base isolation that can be used as a damper for earthquake vibrations on bridges and buildings. The components that make up the LRB are several layers of rubber laminated to steel plates to increase vertical rigidity. LRB is also reinforced with lead cores to dissipate earthquake energy that enters the bridge structure or buildings. This paper will explain the design and production of LRB and test the results of the analysis.

2. LITERATURE REVIEW

2.1 The difference between structures with Seismic Isolation and structures with Fixed Supports

Basic Isolation is a system to separate the horizontal movement of the soil from the horizontal movement of the structure, thus reducing the damage caused by the earthquake to the structure and its contents. The base isolation system absorbs and deflects the energy released from the earthquake before being transferred to the structure. When an earthquake

28

Quick Response Code



Access this article online

Website:
www.enggheritage.com

DOI:
[10.26480/gwk.01.2023.26.37](https://doi.org/10.26480/gwk.01.2023.26.37)

41

Cite The Article: Gambiro, Hari Nugraha Nurjaman, Dwi Dinariana, Martinus Nifotuhu Fau, Suwito, Prijasambada, Henni, Siti Sujatini (2023). Design and Production of Lead Rubber Bearings for Earthquake Absorbers. *Engineering Heritage Journal*, 4(1): 26-37.

occurs, the acceleration on the building will be smaller compared to the ground acceleration. By reducing this acceleration, the earthquake load will decrease.

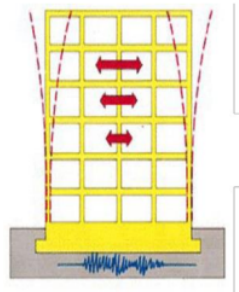

Figure 1: Structural deformation without insulation

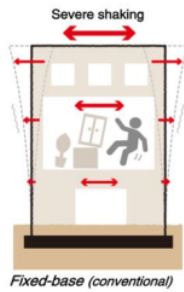

Figure 2: Vibration in uninsulated buildings

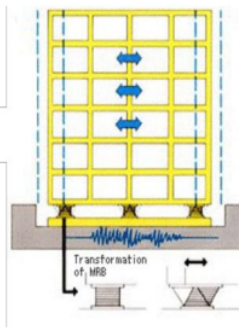

Figure 3: Deformation of structures with insulation

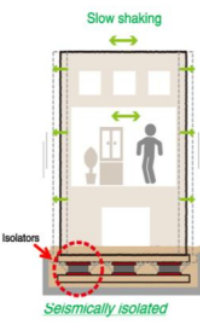

Figure 4: Vibration in buildings with isolation

A structure without insulation (Figure.1) will suffer large story drifts. This behavior will cause the building to suffer damage. Strong vibrations can occur in buildings (Figure. 2) and can cause damage to components and equipment inside the building.

Meanwhile, there is no storey drift in an isolated structure (Figure. 3). The structure is not damaged, even the structure can still function again. The vibrations that occur will also be weak (Figure. 4), so that they do not cause significant damage. Basic isolation really helps the security of important buildings such as hospitals, laboratories and others. Heritage buildings will be easily protected from earthquake loads.

2.2 Characteristics of buildings with Fixed Supports

- There is a deviation between levels in a structure with a fixed support. The top level of the building has the largest deviation, while the ground level is assumed to have no deviation. Characters like this cause the lowest columns of the building to get the biggest.
- The structure has no good dynamic characteristics which increase the earthquake response. The ground acceleration is transmitted to the superstructure as acceleration in the building. This acceleration determines the magnitude of the earthquake force.
- The storey drift at the top of the building can cause large vibration and can damage the property and equipment in the the building.
- The storey drift above is greater than the storey below. This causes the upper level to move faster than the level below it. (G-Force acceleration)

2.3 Seismic Isolation

The vertical load of the building is supported by laminated rubber layers and steel plates. This system has high vertical stiffness and low horizontal stiffness. With a model like this, the pedestal is able to withstand vertical loads, but has the flexibility to reduce earthquake loads.

The natural period of a structure in an isolation system is usually taken to be two seconds. This period was chosen to be long compared to the

predominant period of earthquake shaking and the period of the superstructure at fixed ground conditions. Based on the response spectrum graph and long natural period, the acceleration that occurs will decrease. Natural periods longer than seconds do not significantly reduce acceleration. Decreasing the acceleration can reduce the seismic force

The earthquake load on a building is determined based on the natural period of the building and acceleration of the ground in a certain area. This relationship is shown in the response spectrum. The natural period is practically a function of the number of floors or the height of the building as stated in ASCE 7-16 Section 12.8.2. Based on the Response Spectrum graph, the longer the fundamental period of a building, the less acceleration that occurs. The main thing of base isolation is to extend the fundamental time to obtain a small value of the seismic base shear force (V). Base isolation is usually taken for 2 seconds, because for $T > 2$ seconds the acceleration will be sloping.

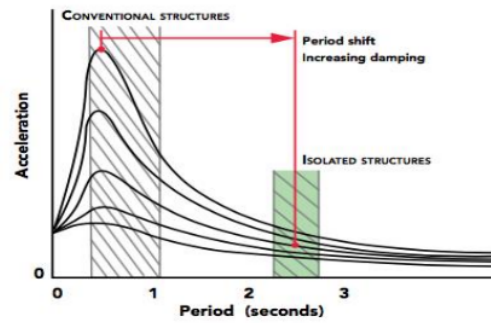

Figure 5: Graph of the extension of the fundamental period in the response spectrum

Source : Doshin Rubber Engineering – Seismic Isolation Base Isolators

2.4 Performance Required For Seismic Isolation Rubber Supporting

- Support the weight of the building.

LRB has a bearing capacity and vertical stiffness that can withstand vertical loads. This character is obtained from the combination of rubber sheets and steel plates that are laminated

- Isolate the building from ground movement.

Ground motion due to the earthquake is not transmitted to the upper structure, because there is a separation of the upper and lower structures. This separation causes the structure acceleration to be lower than the ground acceleration.

- Reduce the amplitude of the earthquake response

Structures without isolation can dampen the amplitude up to 5%. But by using LRB, attenuation can reach 10-30%. This damping reduces the energy of the earthquake that hit the building.

- Restoring buildings after an earthquake.

LRB is designed to have a maximum shear deformation capability while still in an elastic state. This property and low shear stiffness allows the structure to return to its original position when deformed in shear.

2.5 solator basic construction

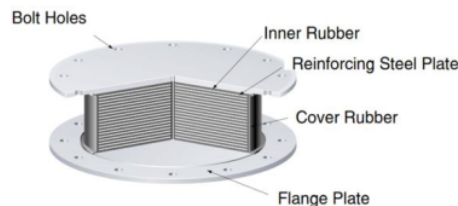

Figure 6 : Detail of Base Isolation

Source : Bridgestone – Seismic Isolation Product Line-up

The elastomeric insulator consists of a thin layer of rubber and steel plates laminated alternately bonded together, giving it the following characteristics:

- i. The high vertical stiffness gives the LRB the ability to support the self-weight of the superstructure. This stiffness is obtained from layers of rubber and steel plates that are installed alternately. If the LRB does not use a steel plate, then all vertical loads will be supported by rubber alone. Rubber has a low vertical modulus of elasticity (10,000 MPa) compared to steel plate (200,000 MPa), so that it can increase the vertical stiffness of the LRB.

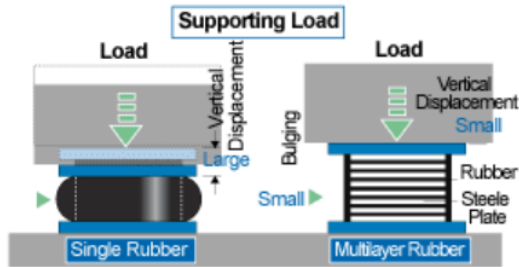

Figure 7: Deformation of insulating supports without steel plate (left) and with steel plate (right) (Source : www.oiles.co.jp)

- ii. Horizontal flexibility allows large deformations during earthquakes. The special property of LRB is its ability to deform in a horizontal direction to reduce earthquake loads on the structure. This capability is obtained from the low horizontal stiffness (shear modulus = 0.3-1.5 MPa). Displacement of the structure due to earthquake loads must be smaller than the maximum displacement of the rubber bearings in an elastic state (design earthquake load stage).

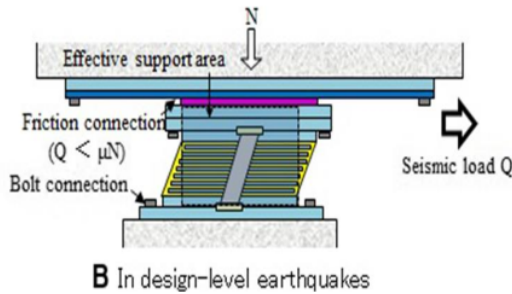

Figure 8: LRB horizontal deformation at design seismic loads

(Source : Practical application of lead rubber bearings with fail-safe mechanism)

- iii. When the earthquake load exceeds the design earthquake load, the LRB will reach an inelastic condition. In this phase the energy of the earthquake load is absorbed by the tin core. Under these conditions, the structure is expected not to collapse.

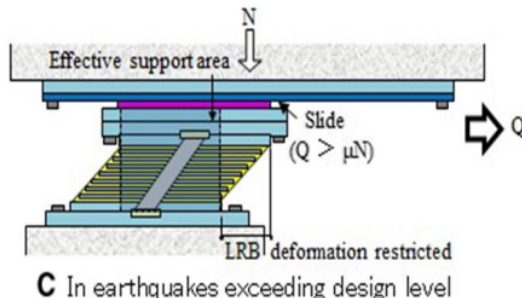

Figure 9: LRB horizontal deformation at maximum seismic loads

(Source : Practical application of lead rubber bearings with fail-safe mechanism)

mechanism)

2.6 Function of Multilayer Rubber (Isolator)

- i. Function as load support
 - a. Steel-reinforced rubber will support a strong building.

LRB vertical strength exists in the rubber layer which has a shear stiffness K_s (B3.7.5.3.1-1) and K_r . By considering H_{eff} , P_{cr} will be obtained which is the vertical bearing capacity as shown in (B3.7.5.4.1-1). The role of the steel plate is to increase the rigidity of the rubber sheet.

- ii. High stiffness in the vertical direction provides a stable support to the building compared to single rubber.

The installation of the steel plate aims to reduce the shear strain γ of the rubber sheet. The more layers of rubber reinforced with steel plates, the greater the vertical (axial) capacity of the LRB.

- iii. Horizontal Elasticity Function (extend period)

- a. Converts earthquake vibrations into slow motion

The uniqueness of the LRB, as well as the basic insulation of the rubber sheet layer, is that it has vertical strength, but has flexibility so that the LRB is easily deformed in the horizontal direction. The large ability of the LRB to deform horizontally causes the structure to vibrate for a long time and results in a decrease in building acceleration which can reduce earthquakes.

- ii. Softness in the horizontal direction dampens strong earthquake vibrations, and extends the period of the building's vibration. By dampening the vibrations that occur, the vibrations in the building can be felt softer as well

- iii. Recovery Function

- a. Returns the building to its original position.

When an earthquake occurs, the building vibrates and deviates. Until a certain time the building will return to its original position. This can happen because the LRB deformation is still in an elastic condition. LRB is designed to have a maximum shear deformation capability under elastic conditions greater than the maximum shear deformation of the structure. Returning the building to its original state will protect the building from damage and collapse.

- b. The restorative force of the rubber will stop the vibration.

Fixed support structures generally have a damping of about 5%. The use of basic isolation as well as LRB in buildings provides attenuation of 10-30%, so that vibrations in buildings will stop quickly.

2.7 Functions and Characteristics of Base Isolation

- i. Isolate the superstructure from the ground/substructure

This isolation aims to prevent the propagation of ground motion to the superstructure, so that the structure acceleration is not the same as the ground acceleration.

- ii. Has high damping $\zeta_b = 10\%$

Damping is important to accelerate the cessation of vibrations in buildings. LRB has the ability to produce such high damping. Even the attenuation can be designed up to 30%.

- iii. Has a long $t_b \geq 2.0$ seconds

From Figure 5 it is shown that if $t_b \geq 2$ seconds, the acceleration value of the structure in the figure will decrease and even slope. This certainly has an effect on decreasing the force of the earthquake. In some references, the damping ratio (ζ_b) can be selected, so that the LRB can be designed with the desired damping ratio.

- iv. Minimize the structure's response to earthquake loads

The upper structure which is separated from the lower structure gets a minimal response to earthquake loads, due to the low LRB horizontal stiffness.

The objective of a seismic isolation system is to improve the performance of a structure at all hazard levels by,

- Minimizing disruption to the use of facilities (Immediate Occupancy Performance Level)

After an earthquake occurs, several building facilities (such as elevators, stairs, emergency exits, pipes, power lines, communications, etc.) may not function normally, so they cannot be used for the evacuation process and cannot be used again. LRB can reduce the possibility of decreased function. This also applies to bridges that must continue to function after an earthquake occurs for emergency response processes such as rescue, evacuation, logistics delivery, restoration processes and others.

- Reducing damaging deformations in structural and non-structural components

The concept of an earthquake-resistant building requires that the building does not collapse, but that the evacuation of occupants can still take place. However, the building cannot be reused immediately. In some cases the building can no longer be used, and even has to be demolished. This condition can occur due to deviations between levels that cause large shocks. This deformation damages the building as described above. Using LRB will avoid drift between levels.

- Reduced acceleration response to minimize damage to non-structural components.

The magnitude of the seismic force on the superstructure is determined by the mass of the building and the acceleration of the structure. In conventional structures that use fixed supports, the acceleration on the subgrade is directly transmitted to the superstructure which causes shocks that can damage the contents of the building. LRB separates the lower structure and the superstructure, so that earthquake energy is not transmitted to the superstructure and reduces acceleration in the building. The use of LRB extends the natural period of a building which can slow down the movement of the structure, thereby minimizing damage to the contents of the building.

- Prevents plastic deformation of structural elements

2.8 LRB Structure

Base insulation, including LRB, provides opportunities for structures to deform while still in an elastic state. The maximum shear displacement of the building must be smaller than the maximum displacement of the LRB, so that the displacement that occurs is still in an elastic condition. This condition prevents plastic deformation of structural elements.

- Protection of the building frame

Deviations between stories in structures with LRB relatively do not occur, so they do not cause internal forces on structural elements (beams and columns) due to lateral loads. These internal forces occur repeatedly so that they can cause degradation of the structure. LRB can prevent damage to structural elements.

- Protection of non-structural components

LRB reduces shocks to buildings, so they can protect non-structural components from damage. This is also possible because there are relatively no deviations between levels in the building.

- Provide Optional Facilities after the earthquake

LRB gives the building the ability to not be damaged, remain intact and function properly. Under these conditions the evacuation process went well and did not cause any casualties. This is said to be an optional facility that can be provided by a building with LRB.

- Protection of Occupants' Life Safety

With minimal damage and still functioning buildings during and after the earthquake, the occupants can save their lives. The evacuation process can run smoothly and safely.

- Improved Building Safety

LRB can prevent damage and collapse of structures, so as to ensure the safety of buildings when an earthquake occurs.

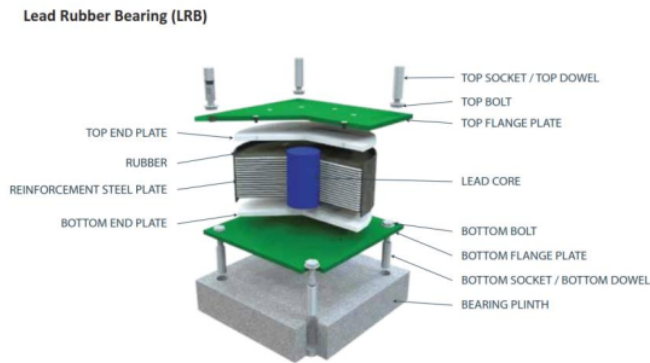

Figure 10: 3D view of LRB

Source : Doshin

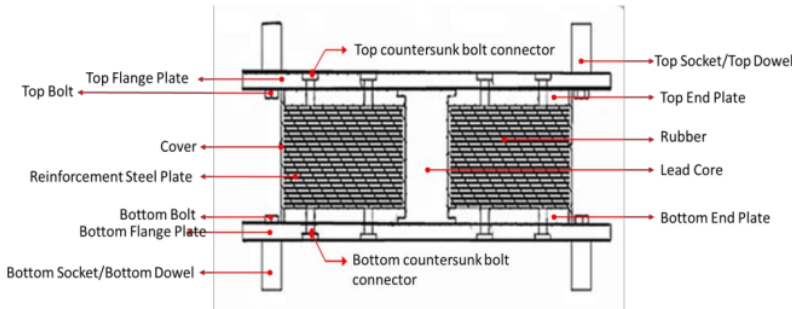

Figure 11: Section of LRB

Characters to be considered in LRB planning are horizontal stiffness (kN/mm), damping (%), horizontal displacement capacity (mm), horizontal stiffness (kN/mm) and vertical load capacity (kN).

A bearing can be designed to have the desired characteristics by adjusting the shear modulus of the rubber compound, the area of contact area of the load, the thickness and number of layers of rubber, and the thickness of the steel plate. Generally, an equivalent linear model is used to represent the stiffness and damping of insulators.

The LRB consists of alternate layers of rubber and steel. The steel plate can greatly increase the vertical rigidity of the bearing, which enables the bearing to support both vertical loads and large shear displacements. The strong bond between rubber and steel is essential for the proper functioning of the insulator. The hysteresis damping of the LRB is greatly influenced by the high purity tin core compared to rubber.

When the need for energy dissipation is high, Lead Rubber Bearings (LRB) are used. Tin with high purity can provide hysteresis damping compared to rubber.

The rubber used can be natural rubber or synthetic rubber. The properties of synthetic rubber vary, some are even worse than natural rubber. Considerations in choosing synthetic rubber relate to durability, while the minimum mechanical properties must be the same or close to natural rubber.

2.9 Spesifikasi Material

Table 1: Material Specification of LRB

Description	Quality of Material	Standard
Inner rubber and rubber cover	Natural Rubber	EN 15129
Laminated steel plate	Min. f_u 400 MPa	SNI 6764 or equivalent
Exterior vulcanized steel plate	Min. f_u 490 MPa	SNI 1729 or equivalent
Steel anchor plate	Min. f_u 490 MPa	SNI 1729 or equivalent
Plumbum/lead core	With 99% purity	
Steel dowels	Min. f_u 569 MPa	ASTM A529 or equivalent
Hexagonal head bolt	Min. f_u 1000 MPa	Guide of bolt installation guide No. 14/SE/M/2015
Flat head countersunk bolt	C1. 8.8 or equivalent	ISO 10642 or equivalent
Nuts and washers	Min. f_u 1000 MPa	Guide of bolt installation guide No. 14/SE/M/2015
Rust protection on steel by painting method	ISO 12944-5	
Rust protection on steel by the Hot-Dip Galvanize Method	ASTM A123	
The cover plate must be protected against corrosion by galvanizing with a minimum thickness of 150 microns or using paint with category C5 [minimum total thickness if using Zinc (Zn) 320 microns and 360 microns if using other materials]		

Source : Table SKh-1.7.47.2.1 LRB Material Isolator Gempa Menggunakan Bantalan Karet Inti Timbal

Table 2: Mechanical and physical properties of low and high damping elastomers

Property	Low damping			Test Method	Property	High damping		Test Method
	Requirement					Moulded Sample	Test piece from device ^a	
Shear modulus ^a MPa	0,35 ≤ G ≤ 0,7	0,7 < G ≤ 1,1	1,1 < G ≤ 1,5		Tensile strength MPa _{min}	12	10	ISO 37 Type 2
Tensile strength MPa _{min}	16			ISO 37 Type 2	Elongation at break % _{min}	400	350	*
Test piece from bearing ^b	14				Tear resistance kN/m _{min}	7		ISO 34 ^c Method A
Elongation at break % _{min}				*	Compression set	60		ISO 815 Type A
Moulded testpiece	450	425	350		70°C, 24h, max			25% compression
Test piece from bearing ^b	400	375	300		Ozone resistance ^d			ISO 1431/1
Tear resistance ^e kN/m _{min}	5	8	10	ISO 34 ^c Method A	Elongation 30% - 96h	no cracks		40°C ±2°C
Compression set ^f				ISO 815 Type A	Accelerated air oven ageing ^g			ISO 188, Method A
70 C, 24h, max	30	30	30	25% compression	Maximum change from unaged value			
Ozone resistance ^d				ISO 1431/1	Hardness (IRHD)	-5, +8		ISO 48
Elongation 30% - 96h	no cracks	no cracks	no cracks	ISO 1431/1	Tensile strength (%)	± 15		ISO 37 Type 2
40 C ±2 C					Elongation at break (%)	± 25		*
Accelerated air oven ageing ^g				ISO 188, Method A				
Maximum change from unaged value								
Hardness (IRHD)	-5, +8	± 25	-5, +8	ISO 48				
Tensile strength (%)	± 15		± 15	ISO 37 Type 2				
Elongation at break (%)			± 25	*				

Source : Table SKh-1.7.47.2.2 - 3 Elastomer Isolator Gempa Menggunakan Bantalan Karet Inti Timbal

Table 3: Properties of Lead

Material: Lead - An Introduction						
Composition: >99.9Pb typically						
Property	Minimum Value (S.I.)	Maximum Value (S.I.)	Units (S.I.)	Minimum Value (Imp.)	Maximum Value (Imp.)	Units (Imp.)
Atomic Volume (average)	0.0182	0.0183	m ³ /kmol	1110.63	1116.73	in ³ /kmol
Density	11.31	11.39	Mg/m ³	706.061	711.055	lb/ft ³
Energy Content	29	54	MJ/kg	3141.82	5850.29	kcal/lb
Bulk Modulus	30	45	GPa	4.35113	6.52669	10 ⁶ psi
Compressive Strength	4	12	MPa	0.580151	1.74045	ksi
Ductility	0.3	0.6		0.3	0.6	NULL
Elastic Limit	4	12	MPa	0.580151	1.74045	ksi
Endurance Limit	2	9	MPa	0.290075	1.30534	ksi
Fracture Toughness	5	15	MPa.m ^{1/2}	4.55023	13.6507	ksi.in ^{1/2}

Material: Lead - An Introduction						
Composition: >99.9Pb typically						
Property	Minimum Value (S.I.)	Maximum Value (S.I.)	Units (S.I.)	Minimum Value (Imp.)	Maximum Value (Imp.)	Units (Imp.)
Hardness	30	65	MPa	4.35113	9.42746	ksi
Loss Coefficient	0.065	0.14		0.065	0.14	NULL
Modulus of Rupture	4	12	MPa	0.580151	1.74045	ksi
Poisson's Ratio	0.435	0.445		0.435	0.445	NULL
Shear Modulus	4	6	GPa	0.580151	0.870226	10 ⁶ psi
Tensile Strength	12	20	MPa	1.74045	2.90075	ksi
Young's Modulus	13	15	GPa	1.88549	2.17557	10 ⁶ psi
Glass Temperature			K			°F
Latent Heat of Fusion	22	26.5	kJ/kg	9.45825	11.3929	BTU/lb
Maximum Service Temperature	293	323	K	67.73	121.73	°F
Melting Point	595	601	K	611.33	622.13	°F
Minimum Service Temperature	0	0	K	-459.67	-459.67	°F

39

<https://www.azom.com/properties.aspx?ArticleID=613>

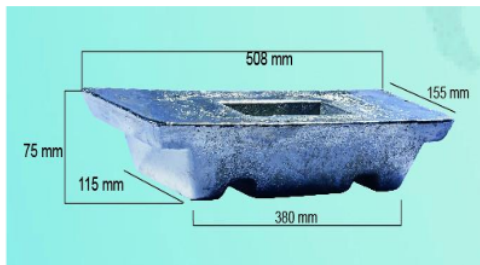

Figure 12: Lead casting

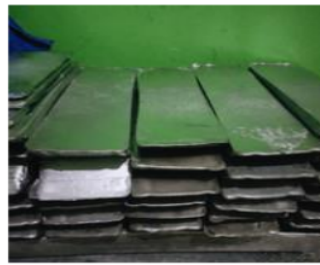

Figure 13: Lead bar

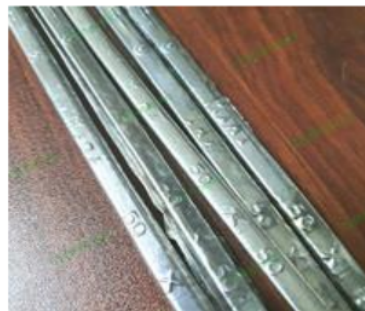

Figure 14: Lead bar



Figure 15: Lead bar

The raw material for lead core is molten tin rods which are then casted to the size according to the design. The tin rod used is a metal element Sn (Stannum with atomic number 50) with a purity level of > 99.9%. Sn exists in nature in the form of the cassiterite compound with the chemical formula SnO₂. This compound has a physical form in the form of tin ore with 10-30% Sn content. This tin ore is obtained from rock or mineral tin (SnO₂) and then processed into metal through 3 stages, namely:

i. Washing

After mining, soil containing tin ore is washed, because a lot of tin ore is mixed with stones, sand, gravel, soil and sticky clay. And also sometimes contain other minerals such as monazite, tungsten, hematite, ilmenite, zircon sand and magnetic iron. Biji timah dicuci dengan air bertekanan dengan debit tertentu.

ii. Separation

a. Separation by size

This is done to obtain uniformity in size to facilitate the next process.

b. Separation by type

Various minerals are found together with tin ore. These minerals are not useful and are not used for further processes.

After washing, the alluvial tin ore is filtered using a trommel screen. This filtering process is to filter out these useless materials. This will be useful for the next stage of separation work. Separation process based on specific gravity, then followed by a rotary dryer.

Pemisahan dilakukan secara gravitasi dan magnetik, Pemisahan gravitasi

dilakukan karena timah merupakan material aling berat. Namun ada material-material lain yang menempel pada bijih timah, sehingga dilakukan pemisahan magnetik.

iii. Drying process

The drying process is carried out in a rotary dryer. The working principle is to heat the iron pipe in the middle of the rotary dryer by flowing the flame obtained from burning using solar power.

iv. Concentration Stage

At this stage the initial Sn level is around 30 - 65% Sn. The Sn content was increased by means of a Jig Concentrator, hammer and rocking table up to 70%.

v. Smelting

Tin ore concentrate undergoes a reduction process at high temperatures (around 900o C) to become tin metal. What is meant by the reduction process is the release of the oxygen bonds that exist in the cassiterite mineral. Reduction using reducing CO gas. The smelting process that occurs is a reaction:

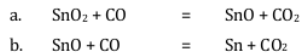

Smelting is carried out in 2 stages. The first stage of smelting is tin concentrate smelting which produces crude tin and slag 1. The tin content in slag 1 is about 20 percent

Slag 2 is then melted again in the second stage of smelting. Smelting in this second stage produces Fe-Sn compounds called hardheads with a Sa content of less than one percent. Hardhead becomes the raw material for stage one smelting.

vi. Refining

The refining process uses heat above the melting point so that the purified material will melt. The tin content in stage 1 is Sn > 90% and the rest are impurities such as As, Pb, Ag, Fe, Cu and Sb. The purification stage of impurities using Kettle Refining, Eutetic Refining and Electrolytic Refining can obtain metal purity of up to 99.93%.

vii. Casting

Tin ingot printing is done manually and automatically. The tools used to manually print tin ingots are a melting kettle with a capacity of 50 tons, a printing pump and metal moulds. Meanwhile, automatic printing uses a melting kettle with a capacity of 50 tons. casting machine and printing pump,

Table 4: Tin grades based on mining locations in Indonesia

BRAND	INGOT	INGOT WEIGHT (kgs)	%Sn (Min.)
BANKA FOUR NINE	Standard	25	99,99
BANKA TIN	Standard	25	99,91
MENTOK TIN	Standard	25	99,90
KUNDUR TIN	Standard	25	99,92
BANKA LOW LEAD (LL) 50	Standard	25	99,94
BANKA LOW LEAD (LL) 100	Standard	25	99,93
KUNDUR LOW LEAD (LL) 100	Standard	25	99,95
BANKA LOW LEAD (LL) 200	Standard	25	99,92
KUNDUR LOW LEAD (LL) 200	Standard	25	99,93

Source : PT. Timah, Tbk

All local tin metal ex PT, Timah, Tbk. having a purity content greater than 99.9%, so that it meets the requirements (Table 1).

3. DESIGN OF LRB

There are many LRB design methods, but this paper will explain the design method based on AASHTO Guide Specification for Seismic Isolation Design 4th Edition - 2014. There are several steps that must be followed as follows :

Step E1 : Determine the elastomeric thickness and number of layers

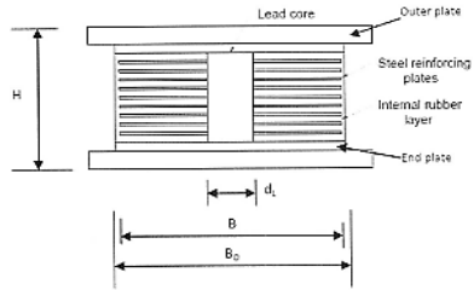

Figure 16: LRB cross section details

The data needed for LRB design:

- Required characteristic strength, Qd per insulator
- Required post-elastic stiffness, Kd per insulator
- The total planned displacement, in, for each insulator. Maximum applied dead and live loads (PDL, PLL) and seismic loads (PSL), which includes seismic live loads (if any) and overturning moment forces due to seismic loads, on the insulator
- Maximum wind load, PwL

Step E2 : Determine the size of the insulator

Tensile strength = 4 - 12 MPa (0,580 - 1,740 ksi)

Yield strength = 2,67 - 8 MPa (0,387 - 1,162 ksi)

Step E2.1 : Determine the diameter of the lead plug, dL

$$d_L = \sqrt{\frac{Q_d}{0.25 \times \pi \times f_y}} \quad (in.)$$

$$d_L = \sqrt{\frac{Q_d}{0.9}} \quad (in.) \quad (B3.7.5.2.1-1)$$

Limitation: $B/3 \geq d_L \geq B/6$

Step E2.2 : Area and diameter of the insulator

$$A_b = \frac{P_{DL} + P_{LL}}{1.6} in.^2 \quad (B3.7.5.2.2-1)$$

The allowable stress for rubber = 1.6 ksi

$$B = \sqrt{\frac{4A_b}{\pi} + d_L^2} \quad (B3.7.5.2.2-2)$$

B values are rounded up. Ab is recalculated.

$$A_b = \frac{\pi}{4} (B^2 - d_L^2) \quad (B3.7.5.2.2-3)$$

B is added cover to become B0, Usually taken 1 in. (25.4mm)

$$B_0 = B + 1.0 \quad (B3.7.5.2.2-4)$$

Step E2.3 : Determine the elastomeric thickness and number of layers

$$K_d = \frac{GA_b}{T_r} \quad (B3.7.5.2.3-1)$$

$$T_r = \frac{GA_b}{K_d} \quad (B3.7.5.2.3-2)$$

- K_d = required shear stiffness (N/mm, lbs/in.)
- T_r = total thickness of elastomer (mm, in.)
- A_b = area of influence (mm², in.²)
- G = rubber shear modulus (N/mm², psi)

Number of layers of rubber

$$n = T_r/t_r \quad (B3.7.5.2.3-3)$$

Due to the rounding of the plan dimensions and the number of layers, the actual stiffness, K_d , will not be exactly what is required. Re-analysis may be necessary if the differences are large (rounding)

Step E2.4 : Overall height

$$H = nt_r + (n - 1)t_s + 2t_c \quad (B3.7.5.2.4-1)$$

t_s = inner shim thickness (1/8 in. or 3175 mm)

t_c = combined thickness of end cover plate (0.5 in. or 12.7 mm) and outer plate (1.0 in. or 25.4 mm)

Step E2.5 : Check the size of the lead core

$$B/3 \geq d_l \geq B/6 \quad (B3.7.5.2.5-1)$$

Step E3 : Check the strain

$$\gamma_c + \gamma_{s,eq} + 0.5\gamma_r \leq 5.5 \quad (B3.7.5.2.3-1)$$

(a) γ_c = maximum shear strain in the layer due to the compressive force

$$\gamma_c = \frac{D_c \sigma_s}{GS} \quad (B3.7.5.2.3-2)$$

D_c = shape coefficient for compression (round shape = 1.0)

σ_s = P_{DL}/A_b

G = shear modulus

S = layer form factor

$$= A_b/(\pi B t_r) \quad (B3.7.5.2.3-3)$$

(b) $\gamma_{s,eq}$ = shear strain due to earthquake loads

$$= d_r/T_r \quad (B3.7.5.2.3-4)$$

(c) γ_r = shear strain due to rotation

$$= \frac{D_r B^2 \theta}{t_r T_r} \quad (B3.7.5.2.3-5)$$

D_r = shape coefficient for circular pedestal rotation (= 0.375)

= design rotation due to DL, LL and the influence of construction loads. The actual value of θ cannot be known immediately and a value of 0.01 is recommended for provisional measurements (LRFD Article 14.4.2.1).

Step E.4 : Check the stability of the vertical load

Article 12.3 requires that the vertical load capacity of all isolators be at least 3 times the applied vertical load (DL and LL) in the laterally undeformed state.

Furthermore, the isolation system must stabilize at 1.2 (DL + SL) when the horizontal displacement equals

- a. $2 \times$ total design displacement, d_r , if in the area of Earthquake Zone 1 or 2, or
- b. $1.5 \times$ total displacement of the plan, d_l , if in the area of Zone 3 and 4.

Step E.4.1 : Check the stability of the vertical load in the undeformed state

Critical load capacity of elastomeric insulator at zero displacement

$$P_{cr(\Delta=0)} = \frac{K_d H_{eff}}{2} \left[\sqrt{\left(1 + \frac{4\pi^2 K_\theta}{K_d H_{eff}^2}\right)} - 1 \right] \quad (B3.7.5.4.1-1)$$

$$H_{eff} = T_r + T_s$$

T_s = total shim thickness

$$K_\theta = E_b I/T_r$$

$$E_b = E(1 + 0.67S^2)$$

E = modulus elastisitas elastomer (= 3G)

$$I = \pi B^4/64$$

Typical elastomeric insulators have a high form factor, in this case:

$$\frac{4\pi^2 K_\theta}{K_d H_{eff}^2} \gg 1 \quad (B3.7.5.4.1-2)$$

and equation B3.7.5.4.1-1 can be reduced to:

$$P_{cr(\Delta=0)} = \pi \sqrt{K_d K_\theta} \quad (B3.7.5.4.1-3)$$

$$\frac{P_{cr(\Delta=0)}}{P_{DL} + P_{LL}} \geq 3 \quad (B3.7.5.4.1-4)$$

Step E.4.2 : Vertical Load Stability in a deformed state

$$P_{cr(\Delta)} = \frac{A_r}{A_{gross}} P_{cr(\Delta=0)} \quad (B3.7.5.4.2-1)$$

A_r = area of overlap between the top and bottom plates of the insulator at a displacement of Δ (Fig. 2.2-1)

$$= B^2(\delta - \sin\delta)/4$$

$$\delta = 2\cos^{-1}(\Delta/B)$$

$$A_{gross} = \pi B^2/4$$

$$\frac{A_r}{A_{gross}} = \frac{(\delta - \sin\delta)}{\pi} \quad (B3.7.5.4.2-2)$$

$$\frac{P_{cr(\Delta)}}{1.2P_{DL} + P_{SL}} \geq 1 \quad (B3.7.5.4.2-2)$$

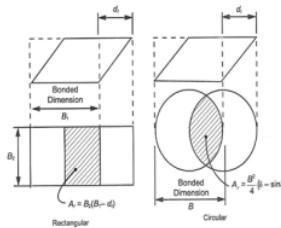

A_o = bonded area of elastomer

A_r = Overlap area between top and bottom plates of insulator at displacement Δ

$$= B^2(\delta - \sin\delta)/4$$

$$\delta = 2\cos^{-1}(\Delta/B)$$

$$A_{gross} = \pi B^2/4$$

4. PRODUCTION

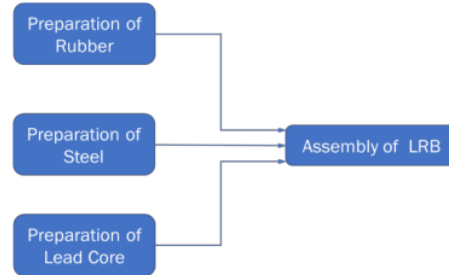

Figure 17: Flow chart of LRB production

Sumber : IRPEC (International Rubber Products Exhibition Centre)

4.1 Rubber Preparation

4.1.1 Raw Material

The main raw material for rubber bearings is rubber compound which is

a mixture of natural rubber and additives. This compound from natural rubber is a material for rubber bearings under normal conditions. For special conditions such as weather resistance, durability, temperature range, etc., synthetic rubber can be used. The form of natural rubber raw material can be seen in Figure 18.



Figure 18: Raw material of natural rubber

The type of synthetic rubber that is often used as a substitute for natural rubber is neoprene. Neoprene rubber has good resistance to oil and weather (ozone, UV and oxygen).

Synthetic rubber is all types of rubber that cannot be classified as natural rubber and is produced artificially. Synthetic rubber production is carried out by making polymers through solution or emulsion polymerization.

Table 3: Comparison between natural rubber and synthetic rubber

MATERIAL	ABBREVIATION	VIBRATION ISOLATION	RELATIVE PRICE	TEMPERATURE RANGE	OZONE, UV RESISTANCE
Natural	NR	Excellent	Good	-60°F to 220°F	Poor
Butyl	IIR	Excellent	Fair	-75°F to 250°F	Good
Ethylene Propylene	EPDM	Good	Excellent	-70°F to 250°F	Excellent
Nitrile	NBR	Good	Good	-30°F to 250°F	Poor
Neoprene / Chlororene	CR	Excellent	Excellent	-60°F to 220°F	Good
Silicone	VMQ	Good	Fair	-175°F to 450°F	Excellent

4.1.2 Mixing

The rubber compounding process is the process of blending certain rubber formulations, including rubber and additives, before starting the vulcanization, or curing process. The ultimate goal of compounding rubber is usually to achieve certain physical and chemical properties.

light) are added, Plasticizers (reduce rubber viscosity and make it more flexible and easy to manipulate), fillers (increase tensile strength or reduce tensile strength), Scents (fragrances to cover or neutralize odors) and curing agents (as a hardener).

In the process, additives such as Antiozonants (prevent cracking due to UV

30 In the mixing stage, the raw materials are mixed together and heated at a temperature of approximately 120 degrees Celsius. The raw rubber is put into the milling machine.

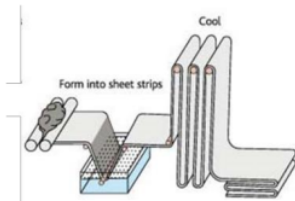

Figure 19: Mixing diagram



Figure 20: Process mixing



Figure 21: Rubber sheet formation

The rubber milling process can be seen in Figures 19, 20 and 21. The raw rubber material as shown in Figure 18 plus additives is put into the milling

machine to produce rubber sheets.

4.1.3 Rubber sheet cutting



Figure 21: Rubber sheet cutting



Figure 22: Rubber sheet shape according to design

Cutting the rubber sheet into small pieces. These pieces are then reduced into sheets according to the shape and size of the LRB to be made. The rubber produced by the milling process in the form of long sheets is cut into smaller pieces (Figure 21). These pieces are then reduced again into sheets according to the shape and size of the LRB to be made (Figure 22).

Cutting the rubber sheet according to the pattern that has been planned (rectangle or circle). Cutting is done with a standard template to get a uniform cut pattern and dimensions. The hole in the center is used to place the lead core.

4.2 Steel Preparation

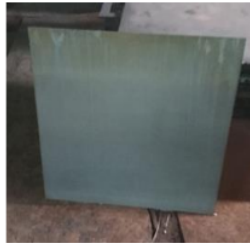

Figure 23: Square steel plate



Figure 24: Round steel plate with hole

4.2.1 Steel plate cutting

The shape and dimensions of the plate are in accordance with the

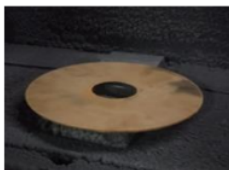

(a)

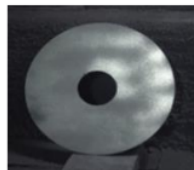

(b)



(c)



(d)

Figure 27: Round steel plate in process

- (a) The steel plate has been sand-blasted.
- (b) The steel plate is coated with a primer bonding agent.
- (c) The steel plate is coated with an adhesive bonding agent to bond the steel plate with the rubber sheet
- (d) Steel plate ready to be assembled into LRB.

4.3 Lead Core Preparation

Tin metal with a purity greater than 99.9% is generally in the form of rods.

design in the form of a rectangle or circle (Fig. 23). The cutting is done with precision and accuracy to ensure the size of the steel plate according to the design.

The holes for the lead core can also be prepared at this stage (Fig. 23). Posisi lubang ini sentris untuk menempatkan inti timah. The diameter of the hole must be exactly the same as the diameter of the lead core to prevent gaps between them and can be deformed together.



Figure 25: Steel cleaning



Figure 26: Sand blast machine

The inner steel plate must be clean and roughened for good adhesion between the steel plate and the rubber sheet. For that the inner steel plate is cleaned with HCl and soaked for 1-2 hours, then roughened with a wire brush or sand blast (Fig. 25 and 26)

This tin metal is heated and melted, then molded with a circle-shaped mold with a diameter according to the design (Fig. 28)

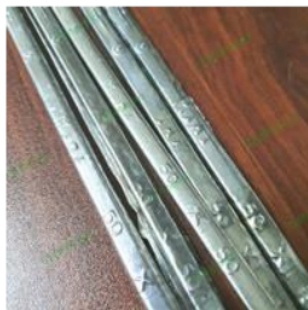

(a)



(b)



(c)

Figure 28: Tin rods were melted to be cast into tin cores

4.4 Assembly Of Lrb

Rubber sheet and steel plate alternate to form a laminated structure. Between the two is coated with a special adhesive. After the number of

layers is in accordance with the plan, the rubber layer and steel plate are vulcanized where they are hot pressed at 140°C about 1 hour, resulting in lamination of rubber sheet and steel plate.



Placement of the rubber sheet on the mould

(a)



Placement of the steel plate on the mould

(b)



Mold closing

(c)



The mold and its contents are put into the press machine

(d)



Vulcanization process (rubber sheet and steel plate being laminated are pressed at 140° C)

(e)



Mold opening

(f)



Remove the laminated rubber sheet and steel plate from the mould

(g)

Figure 29: Vulcanization process

4.5 Finishing Of Lrb

The assembled LRB is equipped with accessories to attach it to the

abutments/piers. The LRB is also protected against rust and other environmental influences. Protection can use anti-rust paint or hot dip galvanized as described in Figure 30.



Drill an no penetrate hole to attach the countersunk bolt that secures the flange plate to the LRB body

(a)



Installation of end plate, flange plate, socket/ dowels/anchor bolt,

(b)



Product has completed. The outer steel plate is painted with zinc-chromat (base paint/primer) and finish paint

(c)

Figure 30: Finishing of LRB

The sequence of LRB final work

- a. The steel plate and rubber sheet are perforated to accommodate the lead core
- b. The steel plate and rubber sheet are laminated
- c. The surface of the steel plate and rubber sheet is coated with an adhesive material
- d. Steel plate (including upper and lower end plates) and rubber sheet pressed by heating to 140 degrees Celsius (vulcanization process)

- e. The lead core is installed in the prepared hole by pressing it so that there are no gaps or holes
- f. Rubber cover is installed around the LRB
- g. Steel top/bottom flange plates and socket/dowels installed

Notes :

The pictures above are for illustration purposes only. There is a rectangular LRB, some are circular. This is due to constraints in getting these images.

5. CONCLUSION

- i. Lead Rubber Bearing (LRB) is one of the building protection systems from earthquake loads. The upper and lower structures are separated to prevent ground vibration from being transmitted to the superstructure. This separation causes the energy of the earthquake to hit the building and cause no damage.
- ii. Lead Rubber Bearing (LRB) is a type of Base Isolation that can reduce earthquake energy by extending the fundamental period of the structure. The main elements of this device are laminated rubber sheets and steel plates which have the characteristics of high vertical stiffness and low horizontal stiffness. This small horizontal stiffness gives the building flexibility. LRB damping a special element, namely a tin core which can dissipate energy.
- iii. LRB is made by a vulcanization process to make the rubber sheet and steel plate a homogeneous element, in which the two materials are pressed at a temperature of 140 degrees Celsius.
- iv. The material for making LRB is widely available in Indonesia, so it has a high local content.

ACKNOWLEDGEMENT

On this occasion, allow us to thank PT Wijaya Karya Beton, Tbk. as a partner in this research and also to PT. Kakada Pratama who works closely with partners and provides a lot of information to the research team in providing information about the LRB production system.

REFERENCES

- AASHTO. 2014. Guide specifications for Seismic Isolation 4th Edition.
- ASCE 7-6. 2023 Minimum Design Loads and Associated Criteria for Building and Other Structures
- BS EN 1337-3:2005. Structural Bearings- Part 3 Elastomeric Bearings
- EN 15129-2009 Anti Seismic Devices
- Amer Hassan, Ahmed Saeed, "Design of LRB Isolators for Seismic Resistant", International Journal of Advances in Mechanical and Civil Engineering Volume 5, Issue 3, June 2018
- Chauhan KalpeshM., Dr. B.J. Shah, "Excel Spreadsheet for Design of Lead Rubber Bearing uses for Seismic Isolation of Bridges", International Journal of Advanced Engineering Research and Studies, E-ISSN2249-8974
- Hiroki Naguchi, Tomotaka Wake, Masashi Yamamoto, Masaru Kikuchi, 2019. Practical application of lead rubber bearings with fail-safe mechanism, Japan Architectural Review, Architectural Institute of Japan,
- Santhosh, H. P., Kumar, K. S., 2013. Seismic Analysis Of Low To Medium Rise Building For Base Isolation, International Journal of Research in Engineering and Technology, 25 November
- Jordan, Processing Alluvial Tin ore in Indonesia: 5 Easy Steps, Henan Fote Heavy Machinery Co., Ltd. (FTM), China, <https://www.ftmmachinery.com/blog/how-to-process-alluvial-tin-ore-in-indonesia.html>
- Oiles, LRB Multilayer Natural Rubber-type Seismic Isolation Device with Lead Plug
- Lead Rubber Bearing
- Shameena Khannavar, M.H.Kolhar., 2016. Seismic Analysis Of Rc Structures Using Base Isolation Technique, International Research Journal of Engineering and Technology (IRJET).
- SKh-1.7.47. 2021. Isolator Gempa Menggunakan Bantal Taret Inti Timbal (Lead Rubber Bearing, LRB) untuk Jembatan, Kementerian Pekerjaan Umum dan Perumahan Rakyat,
- Seismic Isolation Base Isolators (catalogue). 2009. Doshin Rubber Engineering.
- Seismic Isolation Product Line-up Version. 2017. Volume 1 (catalogue), Bridgestone –
- Malaysian Rubber Board (MRB). 1998. http://www3.lgm.gov.my/irpec/flow_seismic.html, IRPEC (International Rubber Products Exhibition Centre)
- Charlie Braun, 2021. What Is A Rubber Compound, Custom Rubber Corp., <https://www.customrubbercorp.com/blog/September-2022/What-is-a-Rubber-Compound, 2022>
- Charlie Braun, 2021. What's The Difference Between Natural And Synthetic Rubber?, Custom Rubber Corp., <https://www.customrubbercorp.com/blog/May-2021/natural-rubber-vs-synthetic-rubber, 2021>
- JXSC, 2023. Mineral Processing Plant & Beneficiation Solutions, JXSC, https://mineraldressing.com/solution/?gclid=Cj0KCQiAjbagBhD3ARIsANRrQEs023SkOv_AnMfOV09X2waldWE5eT6YuQSeF44soPcStTqnZkBNsYaAjErEALw_wcB
- YanTai JinPeng., 2023. Mining Machinery Co. Tin Ore Processing JXSC, <https://mineraldressing.com/solution/tin-ore-processing-plant/>



DESIGN AND PRODUCTION OF LEAD RUBBER BEARINGS FOR EARTHQUAKE ABSORBERS

ORIGINALITY REPORT

14%

SIMILARITY INDEX

11%

INTERNET SOURCES

5%

PUBLICATIONS

5%

STUDENT PAPERS

PRIMARY SOURCES

1	html.pdfcookie.com Internet Source	1%
2	afzir.com Internet Source	1%
3	timah.com Internet Source	1%
4	www.customrubbercorp.com Internet Source	1%
5	earthsciencesmalaysia.com Internet Source	1%
6	www.ftmmachinery.com Internet Source	<1%
7	Encyclopedia of Earthquake Engineering, 2015. Publication	<1%
8	docplayer.net Internet Source	<1%

9	Submitted to Liverpool John Moores University Student Paper	<1 %
10	"Minimum Design Loads and Associated Criteria for Buildings and Other Structures", American Society of Civil Engineers (ASCE), 2017 Publication	<1 %
11	simk.bpjt.pu.go.id Internet Source	<1 %
12	repository.its.ac.id Internet Source	<1 %
13	Submitted to Durban University of Technology Student Paper	<1 %
14	Nishimura, Isao, and Satoshi Suzuki. "Development of base isolation device complied with the ultimate strength design code in Japan", Active and Passive Smart Structures and Integrated Systems 2016, 2016. Publication	<1 %
15	repo.nzsee.org.nz Internet Source	<1 %
16	Submitted to Sim University Student Paper	<1 %

17	icec.neduet.edu.pk Internet Source	<1 %
18	www.igs.org.in:8080 Internet Source	<1 %
19	Hary Agus Rahardjo, Morry Prihanton. "The most critical issues and challenges of fire safety for building sustainability in Jakarta", <i>Journal of Building Engineering</i> , 2020 Publication	<1 %
20	Dingding Shi. "Application Analysis of Seismic Isolation Bearing in Structure Anti-Seismic", 2021 4th International Symposium on Traffic Transportation and Civil Architecture (ISTTCA), 2021 Publication	<1 %
21	doaj.org Internet Source	<1 %
22	iraj.in Internet Source	<1 %
23	jscienceheritage.com Internet Source	<1 %
24	www.techscience.com Internet Source	<1 %
25	challengejournal.com Internet Source	<1 %

26	InCIEC 2013, 2014. Publication	<1 %
27	Submitted to Farnborough College of Technology, Hampshire Student Paper	<1 %
28	Submitted to Federal University of Technology Student Paper	<1 %
29	Submitted to University of Central Lancashire Student Paper	<1 %
30	Submitted to University of Petroleum and Energy Studies Student Paper	<1 %
31	Submitted to Iowa State University Student Paper	<1 %
32	Submitted to Queensland University of Technology Student Paper	<1 %
33	Submitted to University of Hertfordshire Student Paper	<1 %
34	www.ijraset.com Internet Source	<1 %
35	odr.chalmers.se Internet Source	<1 %
36	Cindi Teri Marni Oroh, Fitriana Suprapti, Wilhelmus Hary Susilo. "Improving self-	<1 %

efficacy and life activities of arthritis patients:
A quasy-experiment study", Enfermería
Clínica, 2020

Publication

37

cit.repo.nii.ac.jp

Internet Source

<1 %

38

ijedr.org

Internet Source

<1 %

39

authors.library.caltech.edu

Internet Source

<1 %

40

scholars.unh.edu

Internet Source

<1 %

41

www.researchgate.net

Internet Source

<1 %

42

Hosseini Hashemi, B.. "Study of connection detailing on SMRF seismic behavior for unequal beam depths", Journal of Constructional Steel Research, 201201

Publication

<1 %

43

Mahmoud Fakh, Jaafar Hallal, Hassan Darwich, Hala Damerji. "Effect of Lead-Rubber Bearing Isolators in Reducing Seismic Damage for a High-Rise Building in Comparison with Normal Shear Wall System", Structural Durability & Health Monitoring, 2021

Publication

<1 %

Exclude quotes Off

Exclude matches Off

Exclude bibliography Off