



DEVELOPMENT SEISMIC DESIGN STANDARDS FOR REHABILITATION OF BUILDINGS AFFECTED BY EARTHQUAKE USING DAMPER TECHNOLOGY

H. N. Nurjaman⁽¹⁾, A. Wantoro⁽²⁾, Y. Dharmawan⁽²⁾, B. Boediono⁽³⁾, C.A. Tjiptohardojo⁽⁴⁾, D.L. Barus⁽⁵⁾, S. Duan⁽⁶⁾, M. Guo⁽⁷⁾, B. Hariandja⁽⁸⁾, L. Faizal⁽⁹⁾, Suwito⁽¹⁰⁾, D. Dinariana⁽¹¹⁾,

⁽¹⁾ Chairman, Indonesian Association of Precast and Prestress Engineer, Jakarta, Indonesia, iappi_ind@yahoo.com

⁽²⁾ Director, Waskita Beton Precast Ltd., Jakarta, Indonesia, info@waskitaprecast.co.id

⁽³⁾ Professor, School of Civil and Environmental Engineering, Institut Teknologi Bandung, Indonesia, b.budiono@lapi.itb.ac.id

⁽⁴⁾ Graduate student, Faculty of Civil and Environmental Engineering, Institut Teknologi Bandung, Indonesia, christianalexander.2018@yahoo.com

⁽⁵⁾ Technical Director, Tensindo Kreasi Nusantara, Ltd, Jakarta, Indonesia, dicayosine@gmail.com

⁽⁶⁾ Director, Liuzhou Orient Engineering Rubber Product Co. Ltd., Guangxi, P.R. China, duandh@ovm.co

⁽⁷⁾ Internasional Division Regional Manager, Liuzhou OVM Engineering Machinery Co. Ltd., Guangxi, P.R. China, guox@ovm.co

⁽⁸⁾ Emeritus Professor, Civil Engineering Department, Institut Teknologi Bandung, Indonesia, binsar_hariandja@ymail.com

⁽⁹⁾ Research Institute of Housing and Human Settlement, Ministry of Public Work and Housing, Indonesia, faizblue_21@yahoo.com

⁽¹⁰⁾ Assistant Professor, Construction Engineering and Management Department, Universitas Agung Podomoro, Indonesia, suwito@podomoro.ac.id

⁽¹¹⁾ Associate Professor, Civil Engineering Department, Universitas Persada Indonesia YAI, Indonesia, dwidinariana@gmail.com

Abstract

Since strong earthquake and tsunami took place in Aceh 2004, the frequency of strong earthquakes has increased significantly in several regions in Indonesia. Researches on seismicity and earthquake engineering conducted since 2004 generally result in higher design seismic load in several region in Indonesia and stringent requirements of design standard. This condition means that many buildings that were built before the latest seismic design standard would fail to meet its performance requirements. These buildings, especially important public buildings such as government buildings, schools, hospitals and shopping centers, need technology to improve their structural performances against earthquake with minimal changing to their existing structures. Damper technology is one of such technologies that can dissipate additional earthquake load due to standard design revision. Moreover, in 2019, Indonesia Government planned to begin including damper technology in its seismic design code by adopting ASCE7-16. This study will present part of results from research related to implementation of damper technology in building that will be conducted in 3 year span. In the first year (2019), research focused on the selection of damper technology that is effective in improving seismic performance and has the potential economically to be manufactured in Indonesia. To determine the effectiveness of a damper technology in improving structural performance against earthquake load, a case study illustrating the process and decision regarding rehabilitation of a government office building in city of Palu that was recently struck by earthquake of magnitude $M = 7.4$ on September 28, 2018, will be conducted. A series of response history analyses will be carried out on rehabilitated structure of building used as the case study. In the second year (2020), the selected damper technology will be installed in model structure and will be tested on shaking table to verify its seismic structural performance and to establish Indonesian National Standard for the product. And in the final year (2021), production of damper product in Indonesia will be started and finalization of seismic design standard of building using damper technology will be conducted. The developed seismic design standard can then be used for designing either new building or retrofitting of existing building to achieve latest requirements or restoration of seismic performance of building impacted by earthquake.

Keywords: damper technology; seismic design standard; response history analysis; high performance-based design; shaking table testing



1. Introduction

Since strong earthquake and tsunami took place in Aceh 2004, the frequency of strong earthquakes has increased significantly in several regions in Indonesia. Researches on seismicity and earthquake engineering conducted since 2004 generally result in higher design seismic load in several region in Indonesia and stringent requirements of design standard. This condition means that many buildings that were built before the latest seismic design standard would fail to meet its performance requirements. These buildings, especially important public buildings such as government buildings, schools, hospitals and shopping centers, need technology to improve their structural performances against earthquake with minimal changing to their existing structures. Damper technology is one of such technologies that can dissipate additional earthquake load due to standard design revision.

To determine the effectiveness of a damper technology in improving structural performance against earthquake load, a case study illustrating the process and decision regarding rehabilitation of a government office building in city of Palu that was recently struck by earthquake of magnitude $M = 7.4$ on September 28, 2018, will be conducted. A series of response history analyses will be carried out on rehabilitated structure of building used as the case study.

2. Conditions after the Earthquake

The 2018 earthquake in Sulawesi was a 7.4 Mw earthquake followed by a tsunami that struck the western coast of Sulawesi Island, northern part on September 28, 2018, at 18.02 WITA. The epicenter was 26 km north of Donggala and 80 km northwest of Palu City with a depth of 10 km. Earthquake shocks were felt in Donggala, Palu, Parigi Moutong, Sigi, Poso, Tolitoli, Mamuju and even Samarinda, Balikpapan in Borneo, and Makassar in Celebes, as shown in Fig 1. The earthquake triggered a tsunami to a height of 5 meters in the city of Palu.

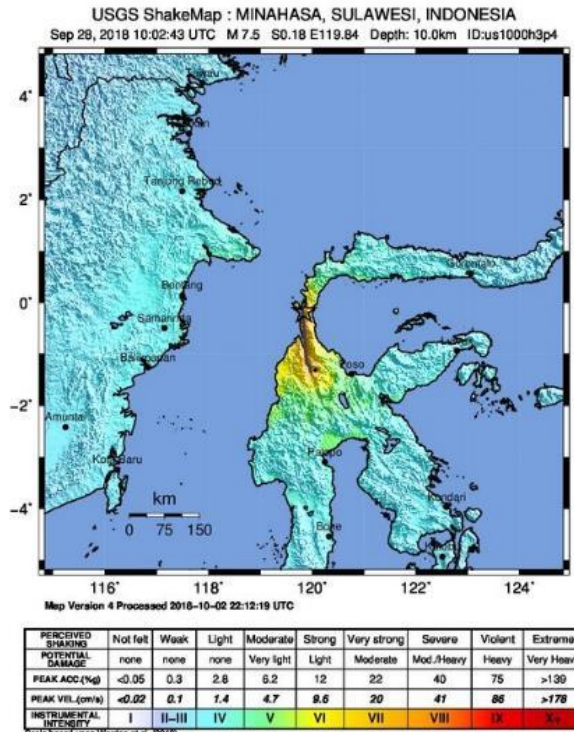

Fig. 1 – USGS Map of the Sulawesi Earthquake



In general, many buildings in Central Sulawesi Province were severely damaged by the earthquake, categorized as moderately to severely damage, including the Cipta Karya and Water Resources Office Buildings in Central Sulawesi Province (Fig 2 and Fig 3). Directorate General Cipta Karya and Water Resources Office building consists of 4 main buildings separated by dilatation. Before the earthquake occurred, these building were functioned as centers for office activities that had 2 parts of activities; Cipta Karya and Water Resources.



Fig. 2 – Damage in the Front of the Building



Fig. 3 – Damage in the Back of the Building

The design of earthquake resistant buildings aims to maintain every vital service of the building's function, limit the inconvenience of occupancy and damage to the building so that it can still be repaired at low cost when a mild to moderate earthquake occurs and avoid fatalities due to the collapse of the building in a strong earthquake event. Performance-based earthquake resistant building design is a process that can be used to design new buildings and strengthen existing buildings with an understanding of the aspects of safety risk (life), readiness for use (occupancy), and the risk of financial losses arising from earthquakes (economic loss). FEMA 356 (2000) sets the level of performance for designing earthquake resistant structures as seen in Fig 4 and Fig 5.

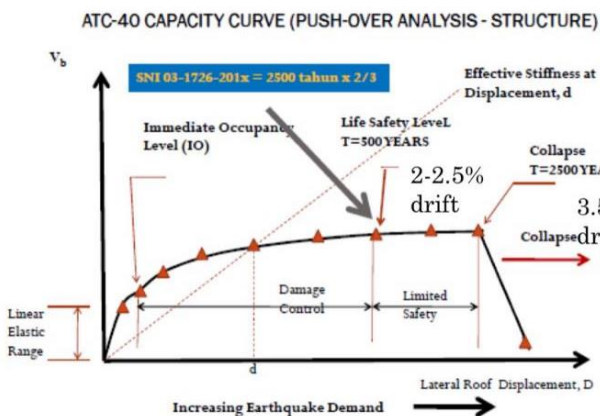

Fig. 4 – Performance Based Planning Graph

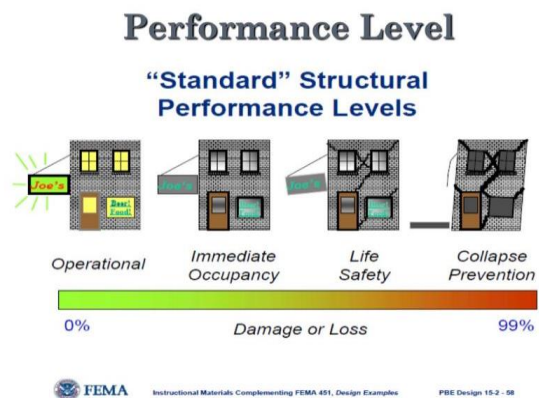

Fig. 5 – Structure Performance Level

From visual investigation, this building Performance Level does not fall in Collapse Prevention (CP) category, where the building Performance Level should be Life Safety (LS). To repair this building, 2 alternative designs were carried out. The first alternative was to use conventional retrofitting with concrete jacketing, and the second alternative using seismic damping resistant.



The data required for evaluating the structure of the Cipta Karya and Water Resources Building of Central Sulawesi Province were obtained as follows:

1. Soil investigation data conducted by the Soil Mechanics Laboratory Team of the Faculty of Engineering, Tadulako University who conducted 2 points of Boring Log. Boring log results show the type of sandy clay soil at the top and sand in the hard soil, with an NSPT value > 50 located at a depth of 12 meters.
2. As-built Drawing Building Cipta Karya and Water Resources of Central Sulawesi Province.
3. Data from the Hammer Test and UVP test results.
4. Direct survey of damaged buildings.

3. Conventional Retrofitting Evaluation

Conventional retrofitting design based on Earthquake Code SNI 1726:2012 which refers to ASCE 374.1-05^[1], and Concrete Code SNI 2847:2013 which refers to ACI 318-11^[2]. The designed Performance Level of the building is Life Safety (LS). The design will result in the cost required to retrofit the building.

3.1 Material

The specifications of the materials used are:

1. Concrete Jacketing: $f_c' = 45$ MPa
2. Rebar : $D \geq 10$ BJTD 40, $f_y = 400$ MPa
: $D \leq 10$ BJTD 24, $f_y = 240$ MPa

3.2 Description of Building Structure System

The building consists of 4 buildings separated by dilatation. In general, the structure may be categorized as a Special Moment Resistant Frame (SMRF) system. The structure was designed using the conventional concrete jacketing.

3.3 Structural Design Method

Analysis was generally carried out in 3 dimensions to obtain optimal results. The analysis was carried out in 2 parts. First, eigen-value analysis was performed to determine the dominant vibration mode and period. Vibration period data from this analysis was used to determine the static earthquake force based on the appropriate spectral response. Structural analysis was divided into two stages, namely the first stage of upper structure analysis which consists of eight layers of structure and was considered to be trapped laterally at the top level of the basement floor. As well as the second stage of the analysis of the basement structure, which is burdened by a combination of earthquake loads originating from the upper structure, the load from the inertia force of the basement floor itself and the load originating from the ground pressure around the basement.

The basement design was made stronger than the upper structure or should not fail earlier than the upper structure, so that the design was still behaving elastic to the planned earthquake load. Analysis of the 3-dimensional structure by paying attention to the torque effect is performed to obtain internal forces. Structural analysis was carried out with the help of the ETABS package program. 3D model can be seen in Fig 6.

3.4 Basic Loading and Load Reduction Parameters

1. Basic Loading

- Concrete γ : 24 kN/m ³	- Super Dead load (SDL) : 1.2 kN/m ²
- Live Load w_{ll} : 2.5 kN/m ²	- Wall : 2.5 kN/m ²
2. Parameter Coefficient Factors Reduction of life load design used in structural planning (*according to SNI 1726:2012*) are :

- Earthquake review (Dynamic analysis) : 0.25	
- Live Load Parking floor : 1.00	



3. Design parameters (reduction factor \emptyset) that are used in structural planning (according to SNI 2847:2013) are:

- Flexural reduction factor : 0.9
- Axial reduction factor : 0.65
- Shear reduction factor : 0.75

4. The effectiveness parameter of moment inertia (cross section of crack) (according to SNI 2847:2013) :

- Beam Components : 0.35 I_g
- Column Components : 0.7 I_g
- Wall Components : 0.7 I_g

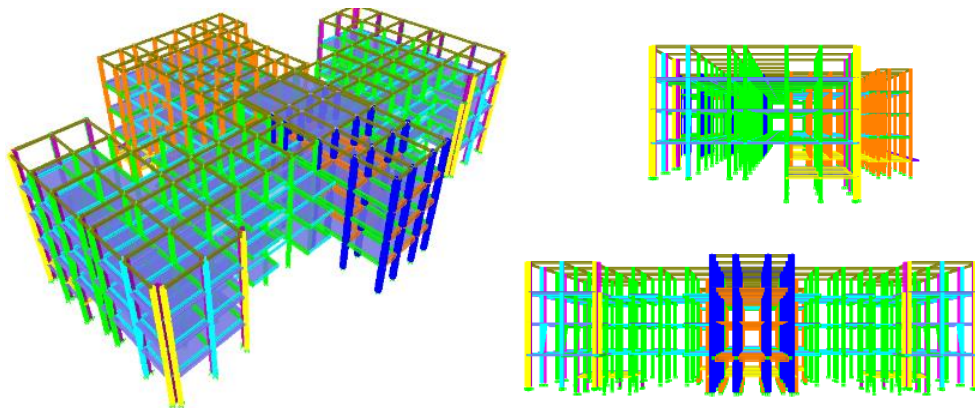

Fig. 6 – 3D View, Front View and Side View of Buildings

3.5 Determination of the Force - Earthquake Structure of the Upper Structure

For a review of earthquake forces the data used are as follows:

3.5.1 Bedrock Acceleration Map (according to SNI 1726:2012)

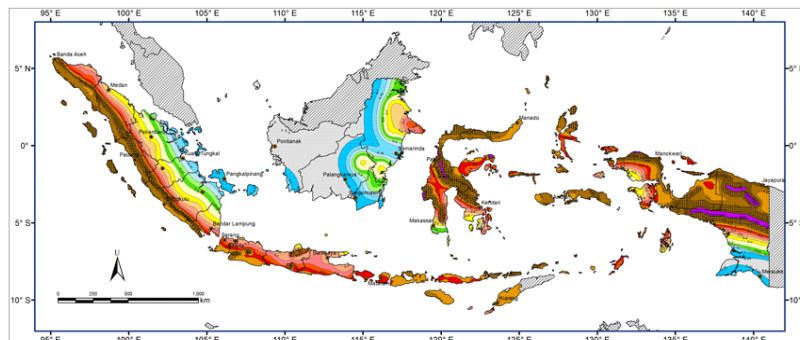

Fig. 7 – Earthquake Acceleration Earthquake Map in Short Period

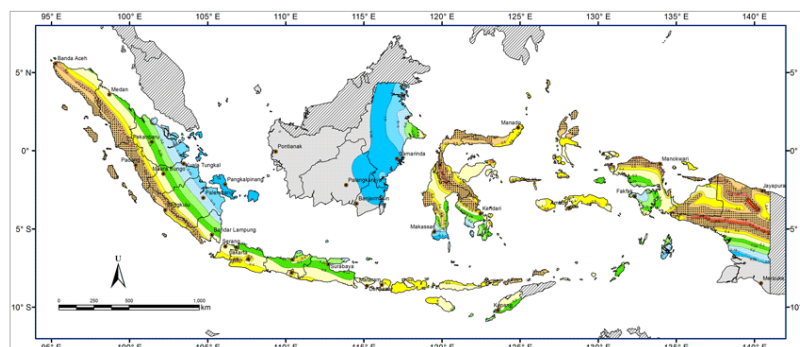

Fig. 8 – Earthquake Acceleration Earthquake Map in 1 second period

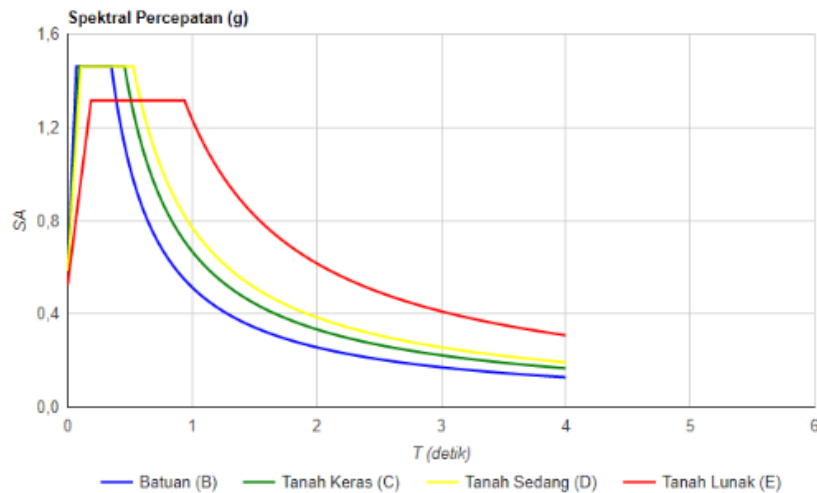

Fig. 9 – Graph of Earthquake Response Spectrum in Palu Region

3.5.2 Building Risk Category

This building is included in the risk category II with the earthquake priority factor value used $I_e = 1$ (Based on Table 1 and Table 2 in SNI 1726: 2012).

3.5.3 Reduction Factor, $R = 8$

The results of the determination of earthquake parameters from the bedrock acceleration map, soil conditions, and the above primacy factors were obtained that the building is included in the seismic design category E so that the structural system used was a reinforced concrete frame structural system for special moment bearers. (Based on point C.5, Table 9 SNI 1726: 2012).

3.6 Eccentricity of Upper Structure Plan

Distance between the center of mass and the center of rotation of the floor level e must be reviewed an eccentricity of the plan e_x for the direction of the earthquake X and e_y for the direction of the earthquake Y. If the largest horizontal size of the floor plan of the building structure on that level floor, measured perpendicular to the direction of earthquake loading, expressed as B and L, then the eccentricity of plan e must be determined as follows:

$$e_x = e_{ox} + (0.05 B A_x) \text{ and } e_y = e_{oy} + (0.05 L A_y)$$

$$A_x/A_y = (\delta_{\max} / 1.2\delta_{\text{avg}})^2$$

e_{ox} and e_{oy} is innate eccentricity

$0.05 B A_x$ and $0.05 L A_y$ is an unexpected eccentricity

A_x and A_y is an unexpected torque magnification factor. A_x and A_y must be ≥ 1.0

Table 1 – Determination of the value of A_x and A_y

LANTAI	δ_A (maks)	δ_B (Min)	δ_{avg}	A_x	$A_x < 1$	LANTAI	δ_A (maks)	δ_B (Min)	δ_{avg}	A_y	$A_y < 1$
LTRB	0.049	0.038	0.043	0.883	...ok	LTRB	0.051	0.050	0.05050	0.700	...ok
LT4	0.039	0.029	0.034	0.916	...ok	LT4	0.041	0.041	0.04050	0.694	...ok
LT3	0.028	0.020	0.024	0.950	...ok	LT3	0.028	0.028	0.02800	0.694	...ok
LT2	0.013	0.008	0.011	1.051	...cek	LT2	0.012	0.012	0.01220	0.694	...ok
LT1	0.002	0.000	0.001	2.778	...cek	LT1	0.002	0.000	0.00095	2.778	...cek



3.7 Building Mass and Modal Participation of Structure Above

The mass of the building per floor as shown in Table 2 below:

Table 2 – Mass per Floor Diaphragm Unit

Story	Diaphragm	MassX	MassY	MMI	XM	YM
LTRB	D5	112.51	112.51	3385.3	31.20	16.54
LT4	D4	2586.22	2586.22	1093631.2	31.22	21.64
LT3	D3	2627.90	2627.90	1105179.8	31.24	21.60
LT2	D2	2595.24	2595.24	1099637.5	31.23	21.55
LT1	D1	967.67	967.67	300559.1	31.25	34.15

3.8 Determination of the Structural Vibration Period

Based on Article 7.8.2 SNI 1726: 2012, the fundamental period of the T structure may not exceed the coefficient results for the upper limit of the period calculated $C_u T_a$ from table 14 and the fundamental period of the T_a approach is calculated in accordance with Article 7.8.2.1 SNI 1726: 2012.

if $T_{computed}$ is $> C_u T_a$ use $C_u T_a$
 if $T_a < T_{computed} < C_u T_a$ use $T_{computed}$
 if $T_{computed} < T_a$ use T_a

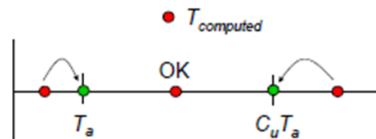

The natural vibrating period of the building is as follows:

Table 3 – Vibration Period

MODAL PERIODS AND FREQUENCIES

MODE NUMBER	PERIOD (TIME)	FREQUENCY (CYCLES/TIME)	CIRCULAR FREQ (RADIAN/TIME)
Mode 1	0.78259	1.27781	8.02869
Mode 2	0.73442	1.36162	8.55531
Mode 3	0.65237	1.53287	9.63130
Mode 4	0.22190	4.50661	28.31586
Mode 5	0.21345	4.68504	29.43695
Mode 6	0.18725	5.34056	33.55572
Mode 7	0.14309	6.98865	43.91101
Mode 8	0.12801	7.81203	49.08442
Mode 9	0.12714	7.86508	49.41778
Mode 10	0.12368	8.08556	50.80305
Mode 11	0.11849	8.43956	53.02732
Mode 12	0.11815	8.46352	53.17785

$T_a = 0.0466^\alpha = 0.6938$ sec

(according to table 15, SNI1726:2012)

$T_{max} = 1.4 \times 0.6938 = 0.9714$ sec

(according table 14, SNI1726:2012)

So the value of the period that occurs is =

$T_x = 0.7825$ sec $< T_{max} = 0.9714$ sec Ok

$T_y = 0.7344$ sec $< T_{max} = 0.9714$ sec Ok



3.9 Earthquake Force Calculation at Upper Structure Design

The results of dynamic analysis for cumulative shear forces in the x and y direction can be seen in Fig. 10 below:

Determination of used earthquake force or design in X & Y direction:

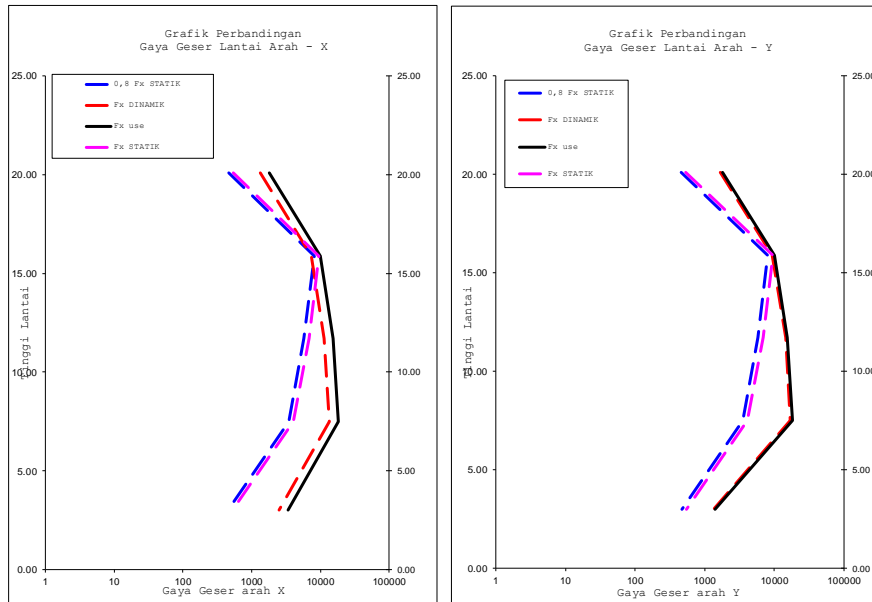

Fig. 10 – Graph of comparison of shear force in X-direction and Y-direction

3.10 Building Structure Analysis Performance

In Article 7.8.6 SNI 1726:2012, it is determined that the deviation between design floors (Δ) must be calculated as the difference in deflection of the center of mass at the top and bottom levels reviewed. The mass center deflection at the level (δ_x) must be determined according to the following equation:

$$\delta_x = C_d \delta_{xe} / I_e$$

C_d = deflection amplification factor (according table 9 SNI 1726:2012) = 5.5

δ_{xe} = deflection at the required location

I_e = earthquake priority factor = 1

Limitation of inter-floor deviation of Δ_a level as stipulated in Article 7.12 SNI1726: 2012 is $0.02h_{sx}$ with h_{sx} as high level below level x.

Calculation of level deviations between floors based on minimum shear forces and period values to calculate deviations between floors (in accordance with Article 7.8.6.1 and 7.8.6.2 SNI 1726: 2012). Calculation of deviation between floors also takes into account the default torque and unexpected torque.

The deviation between floors is based on the followings as shown in the following Table 4:

Table 4 - Intersection between floors in X-direction and Y-direction

Story	h_{sx} (mm)	δ_{xe} (mm)	$\delta_x=C_d.\delta_{xe}/I_e$	Δ	$\Delta_a=0.02h_{sx}$ (mm)	$\Delta < \Delta_a$	Story	h_{sx} (mm)	δ_{xe} (mm)	$\delta_x=C_d.\delta_{xe}/I_e$	Δ	$\Delta_a=0.02h_{sx}$ (mm)	$\Delta < \Delta_a$
LTRB	4200	35.70	130.90	13.93	84.00	...ok	LTRB	4200	49.30	180.77	32.27	84.00	...ok
LT4	4200	31.90	116.97	34.83	84.00	...ok	LT4	4200	40.50	148.50	45.83	84.00	...ok
LT3	4200	22.40	82.13	44.73	84.00	...ok	LT3	4200	28.00	102.67	57.93	84.00	...ok
LT2	4500	10.20	37.40	28.23	90.00	...ok	LT2	4500	12.20	44.73	37.77	90.00	...ok
LT1	3000	2.50	9.17	9.17	60.00	...ok	LT1	3000	1.90	6.97	6.97	60.00	...ok



The influence of P-delta is calculated according to Article 7.8.7 SNI 1726-2012

The effect of P-delta should not be taken into account if the stability coefficient, $\theta \leq 0.1$

$$\theta = \frac{P_x \Delta I_e}{V_x h_{sx} C_d}$$

P_x = total vertical design load at and above level x (kN)

Δ = deviation between floors design level (mm)

I_e = earthquake priority factor

V_x = seismic shear force between level x and x-1 (kN)

h_{sx} = story height above level x (mm)

C_d = deflection amplification factor

Table 5 - P-delta effect in X-direction

LANTAI	h_{sx} (mm)	Δ	P	V	I_e	C_d	θ	θ max	$\theta < 0.1$
LTRB	4200	2.533	1103.68	1785.40	1.5	5.5	0.000	0.0909	...ok
LT4	4200	6.333	25370.81	9865.25	1.5	5.5	0.001	0.0909	...ok
LT3	4200	8.133	25779.69	15317.54	1.5	5.5	0.001	0.0909	...ok
LT2	4500	5.133	25459.32	18032.34	1.5	5.5	0.000	0.0909	...ok
LT1	3000	1.667	9492.87	3378.16	1.5	5.5	0.000	0.0909	...ok

Table 6 - P-delta effect in Y-direction

LANTAI	h_{sx} (mm)	Δ	P	V	I_e	C_d	θ	θ max	$\theta < 0.1$
LTRB	4200	5.867	1103.675	1796.14	1.5	5.5	0.000	0.0909	...ok
LT4	4200	8.333	25370.811	9952.70	1.5	5.5	0.001	0.0909	...ok
LT3	4200	10.533	25779.686	15410.89	1.5	5.5	0.001	0.0909	...ok
LT2	4500	6.867	25459.315	18086.18	1.5	5.5	0.001	0.0909	...ok
LT1	3000	1.267	9492.8731	1415.14	1.5	5.5	0.001	0.0909	...ok

From the table above it can be seen that the value of $\theta \leq 0.1$ in both the X and Y directions, so in planning, this structure does not take into account the effect of P-delta.

3.11 Loading Combination

In accordance with the specification in Article 7.4.2 SNI 1726:2012, the combination of loading due to the influence of earthquake loads must be taken into account to the effect of horizontal earthquake loads and the effect of vertical earthquake loads. The effect of horizontal earthquake load is determined by including the effect of the redundancy factor ρ as determined in Article 7.3.4 SNI 1726:2012. The effect of the vertical earthquake load is determined by incorporating the factor of the acceleration parameter of the design response spectrum in the short period of S_{DS} as determined in Article 6.10.4 SNI 1726:2012.

By entering the factor $\rho = 1.3$ (for the seismic design category E) and the value of $S_{DS} = 1.315$.

3.12 Estimated Cost

Estimated Concrete Jacketing method cost are around 480,000 USD.



Fig. 11 – Concrete Retrofitting Design & Process

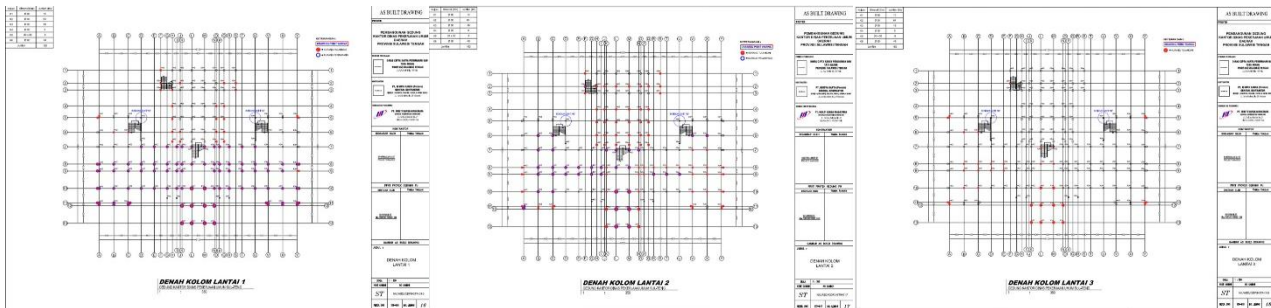

Fig. 12 – Column Retrofit Layout

4. Seismic Damping Design

Concept and mechanism of seismic with seismic isolation is shown in Fig 13. The purpose of seismic isolation is to reduce the effect of the ground motion to structure, thus avoid destruction. To achieve this, the basic cycle of structure can be extended to avoid the size of seismic energy concentration, thus reduce the seismic force of structure as shown in Fig 14. However, the reduction of seismic force by extension of structural cycle comes inevitably with the larger structural displacement, as shown in Fig 15, arising difficulties in design. In order to control the large deformation within limits, a damper can be incorporated into the structure to increase the damping and decrease the displacement of the structure. It can be seen from Fig 14 that the dynamic acceleration of structure can be decreased with increasing the damping of structure [3].

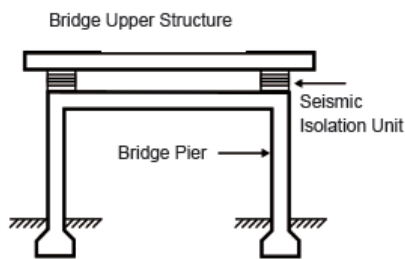

Fig. 13 – Sectional View of the Seismic Isolation

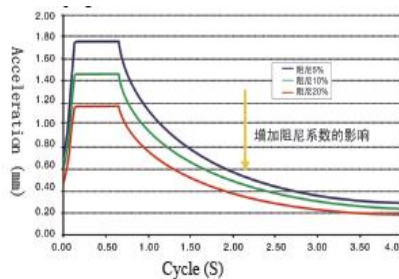

Fig. 14 – Impacts of Damping on the Acceleration of Upper Structure

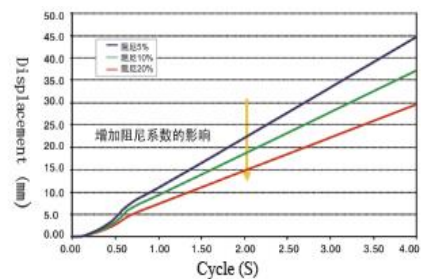

Fig. 15 – Impacts of Damping on the Displacement of Upper Structure



The structure seismic isolation technique is to extend the natural vibration cycle of structure by a seismic isolation unit, reducing the seismic displacement response at the top of pier or foundation while attenuating the acceleration response of upper structure, so as to ensure the structure safety. The principle of seismic isolation is to extend the natural vibration cycle of structure by a seismic isolation unit, increasing the damping coefficient to reduce the acceleration response of structure in the earthquake; and at the same time distributing the seismic force evenly over every pier, averting the seismic force from concentrating on one pier.

Performance of the Lead Rod Damping Seismic Bearing can be seen in Fig 16:

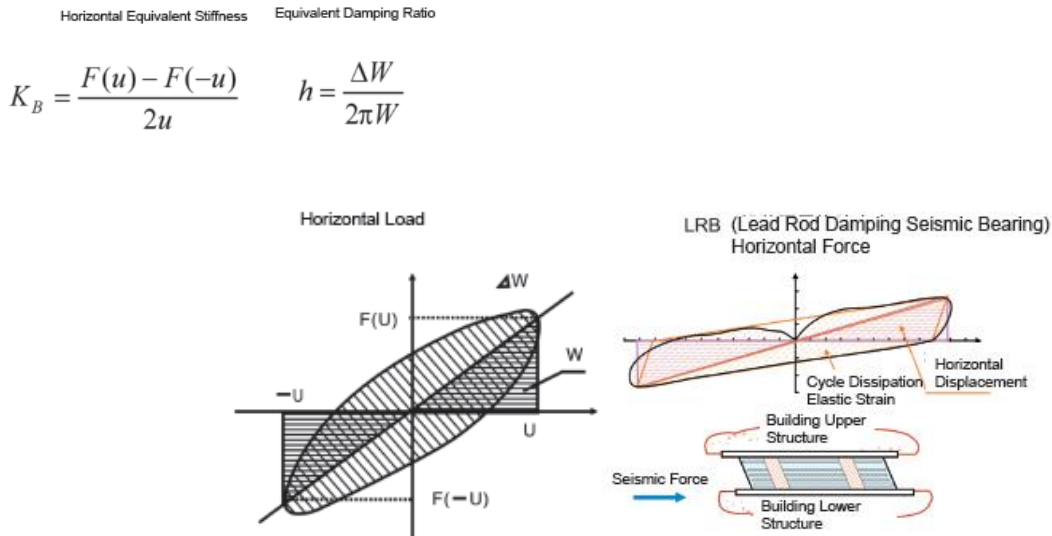

Fig. 16 – Horizontal Load and Force Performance of Lead Rod Damping Seismic Bearing

Dimensions of the Lead Rod Damping Seismic Bearing can be seen in Fig 17.

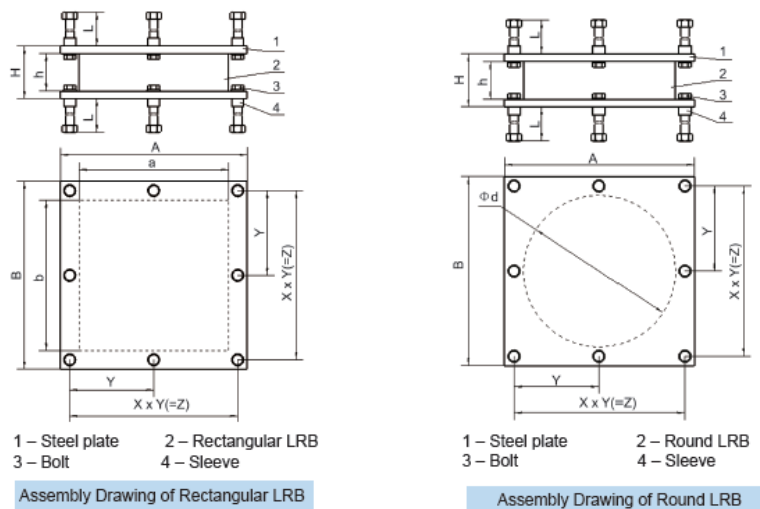

Fig. 17 – Dimensions of the Rectangular LRB and Round LRB



Fig. 18 – Seismic Bearing Installation

The estimated cost for Seismic Damping Design are around 1,100,000 USD if performance level is Immediate Occupancy (IO), or around 600,000 USD if performance level range from Immediate Occupancy (IO) to Life Safety (LS).

5. Conclusion

From the results of the structural inspection and evaluation of the Cipta Karya and Water Resources building, the following conclusions are made:

1. The main structure was found to have structural damage in the column and beams, especially the condition of the architectural components that have been tilted and broken. Such performance conditions have already exceeded Life Safety performance limits. Improvement/strengthening can still be made to bring the building performance back into Minimum Performance Requirements (Life Safety).
2. Stairs found to experiencing severely damages (cracked and tilted), thus exceeds the Near Collapse performance limits. The stairs must be demolished.
3. Estimated cost for alternative construction engineering are proposed as follow:
 - a) Concrete Jacketing: 480,000 USD
 - b) Seismic Damping Design
 - If performance level is Immediate Occupancy (IO): 1,100,000 USD
 - If performance level range from Immediate Occupancy (IO) to Life Safety (LS): 600,000 USD

6. References

- [1] ACI 374.1-05, Acceptance Criteria for Moment Frames Based on Structural Testing and Commentary
- [2] ACI 318-11, Building Code Requirements for Structural Concrete
- [3] OVM 2012, Seismic Mitigation and Isolation Products for Structure